

Linear Specification

SK8513(B)

— ALS series



【Basic Parameters】

- Material: AL6063-T5,spraying
- Coating: White
- Length: 2500mm[98.43"]/0-2500mm[0"-98.43"]
customizable(Other lengths on request)
- Application: Indoor
- Installation: Recessed
- IP grade: IP20
- Certification: ROHS、 Reach
- Warranty: 5 years

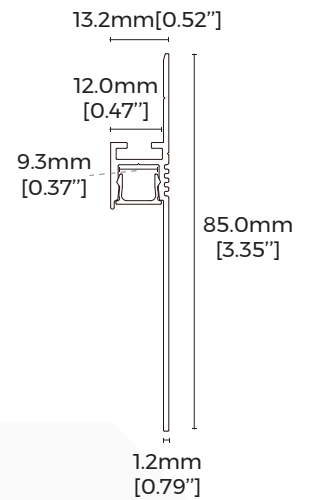
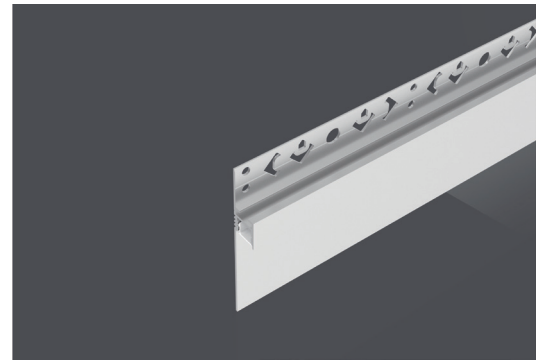

【Luminaire Parameters】

Version	Model	Length	Input Voltage (V)	Max. Current (A/m)	Type Power (W/m)	Max. Power (W/m)	CRI	CCT	Lumen (LM/m)
Normal	SK8513(B)	1000mm (3.28ft)	24	0.28 (0.08A/ft)	6.6 (2.01W/ft)	7.3 (2.21W/ft)	>90	2700K	193 (59LM/ft)
								3000K	196 (60LM/ft)
								4000K	211 (64LM/ft)
								6000K	211 (64LM/ft)

Note:

1. The above parameters were tested based on 1M[3.28'] standard product and D6140-24V-8mm,Ra90,4000K light source;
2. luminous flux is allowed to have a $\pm 10\%$ error range;
3. The above parameters are typical values.

[Optical Parameter]

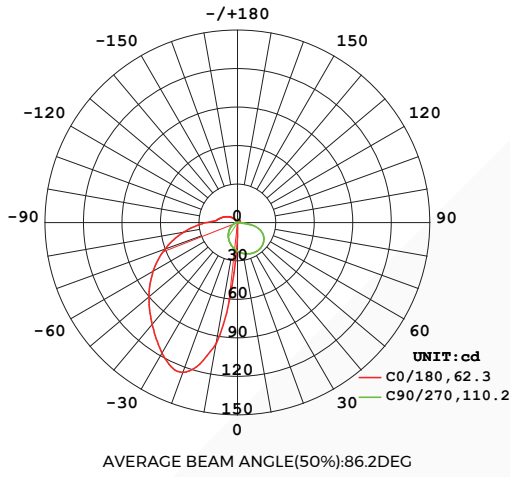

Luminous intensity distribution diagram

Flux out:80.50 lm

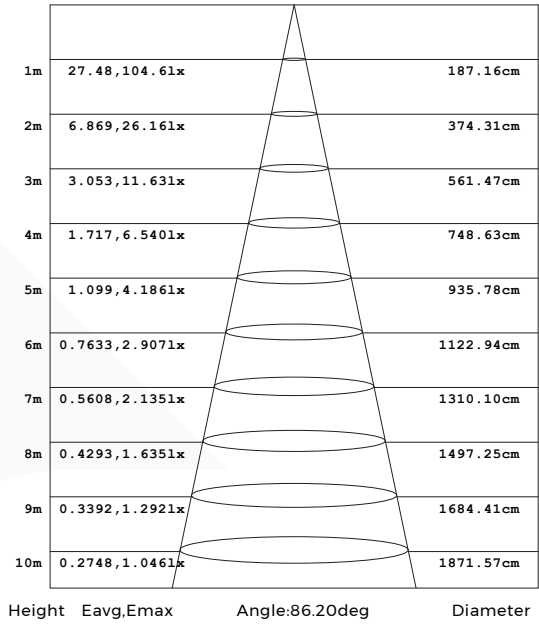

Note:The Curves indicate the illuminated area and the average, illumination when the luminaire is at different distance.

AAI Figure

[Product mechanical data]



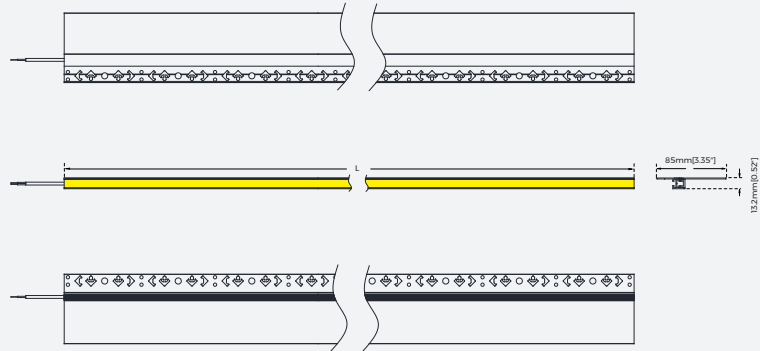
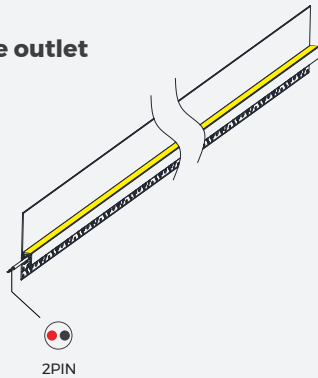

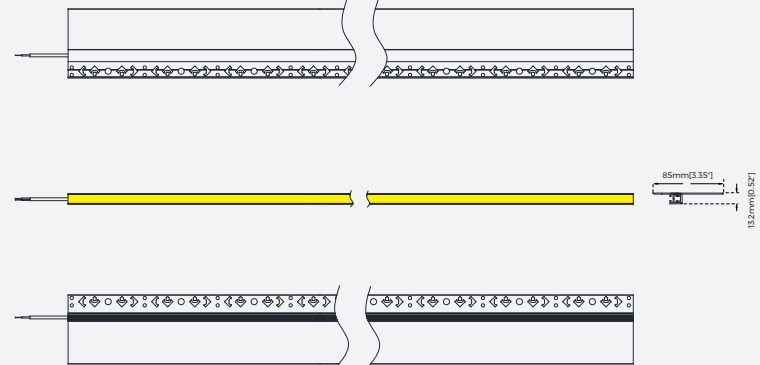
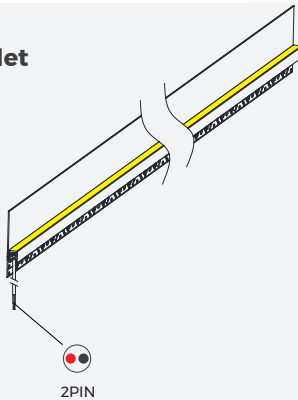

• Straight wire outlet

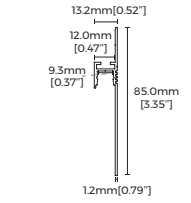

• Bottom wire outlet

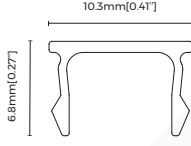

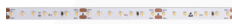
[Product Accessories Information]

Picture	Section size	Name	Description	Model	Note
	 13.2mm[0.52"] 12.0mm[0.47"] 9.3mm[0.37"] 85.0mm[3.35"] 12mm[0.79"]	Profile	Material: AL6063-T5 Surface processing: Spraying Size: L2500*W13.2*H85.0mm [Inch size: L98.43"*W0.52"*H3.35"]	/	/
	 10.3mm[0.41"] 6.8mm[0.27"]	Diffuser	Material: PC Light transmittance: >65% Size: L2500*W10.3*H6.8mm [Inch size: L98.43"*W0.41"*H0.27"] PC feature: The diffuser will extend (shrink) 0.8mm/m when the temperature raises (drops) 10°C	/	/
	/	Screw	Material: Carbon Steel Size:M3.5*40mm [Inch size:M0.14"*1.57"]	CL-01	/
	 8mm[0.31"] 50mm[1.97"]	Flexible Strip	Material: FPC CCT: 2700/3000/4000/6000K CRI>90;Voltage: 24V; Power: 6.6W/M [2.0W/ft]; Lumen: 710LM/M [216LM/ft]; Width: 8mm [0.31"]; Minimum cutting unit: 50mm [1.97"];	D6140-24V-8mm	/

[Packing]

Model	Modes of packing	Quantity /box	Quantity /carton	NW /carton/(kg)	Carton (kg)	CW /carton/(kg)	Size (mm/carton)
ALS-SK8513 FDXWX2500(B)-BC	Bulk Packaging	/	20	23.40	1.60	25.10	2580*180*180 [101.6"*7.1"*7.1"]
ALS-SK8513 FDXWX2500(B)-DC	Single-Unit Inner Box Packaging	1	/	/	/	/	/

[Attentions]

1. Non-professionals are prohibited from installing, disassembling and repairing the product.
2. Avoid scratching, distortion and irregular bending of the product during installation; otherwise it may cause irreparable damage to the product.
3. Please use professional cutting tools when cutting
4. Do not use any acid or alkaline adhesive to fix products
5. The product is only suitable for indoor dry places, can not be used in outdoor, seaside or wet environment.
6. PC features: Each 10°C rise or drop will make diffuser extend or shrink 0.8mm/m, please confirm before processing and use